

18 STÖGRA panel mount / 19 inch-systems series ELK / ELR

The panel mount / 19 inch rack system series ELK/ELR is a mains ready single or multiple axis stepping motor control which can be mounted e.g. in a switch cabinet and can be connected easily via screw terminals. ELK/ELR-systems include plug ports for STÖGRA amplifier boards series SE...[E50] V31/V33 with 32-pole connector VG (DIN 41612 type D) or position controls series SERS.

Each power amplifier plug port additionally includes a plug port for a fan board. In that way fans can be installed easily also afterwards.

All connections (mains, motor and control signals) are via screw terminals or spring terminals (signal connections at ELR racks). ELK/ELR racks are available with and without integrated power supply (connection to 230VAC/50Hz – also available for 115VAC/60Hz). All ELK-/ELR-racks with power supply include in standard version a second (galvanical isolated) 24VDC output.



ELK... front side

ELR... rear side

ELR... front side

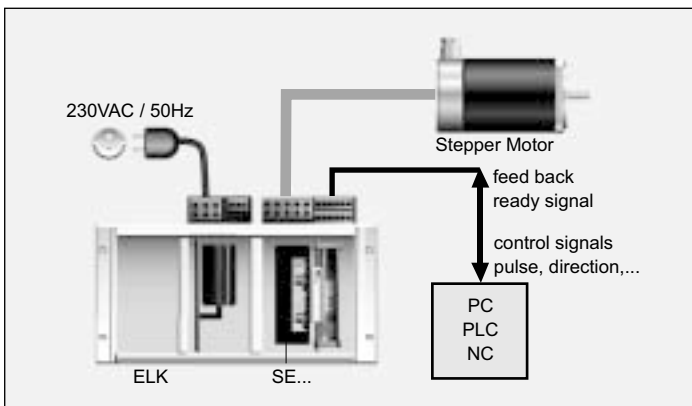

ELK... with SE...front side

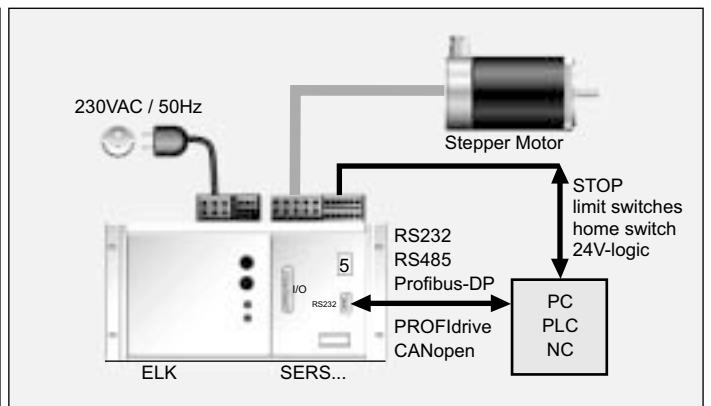

ELK... with SERS front side

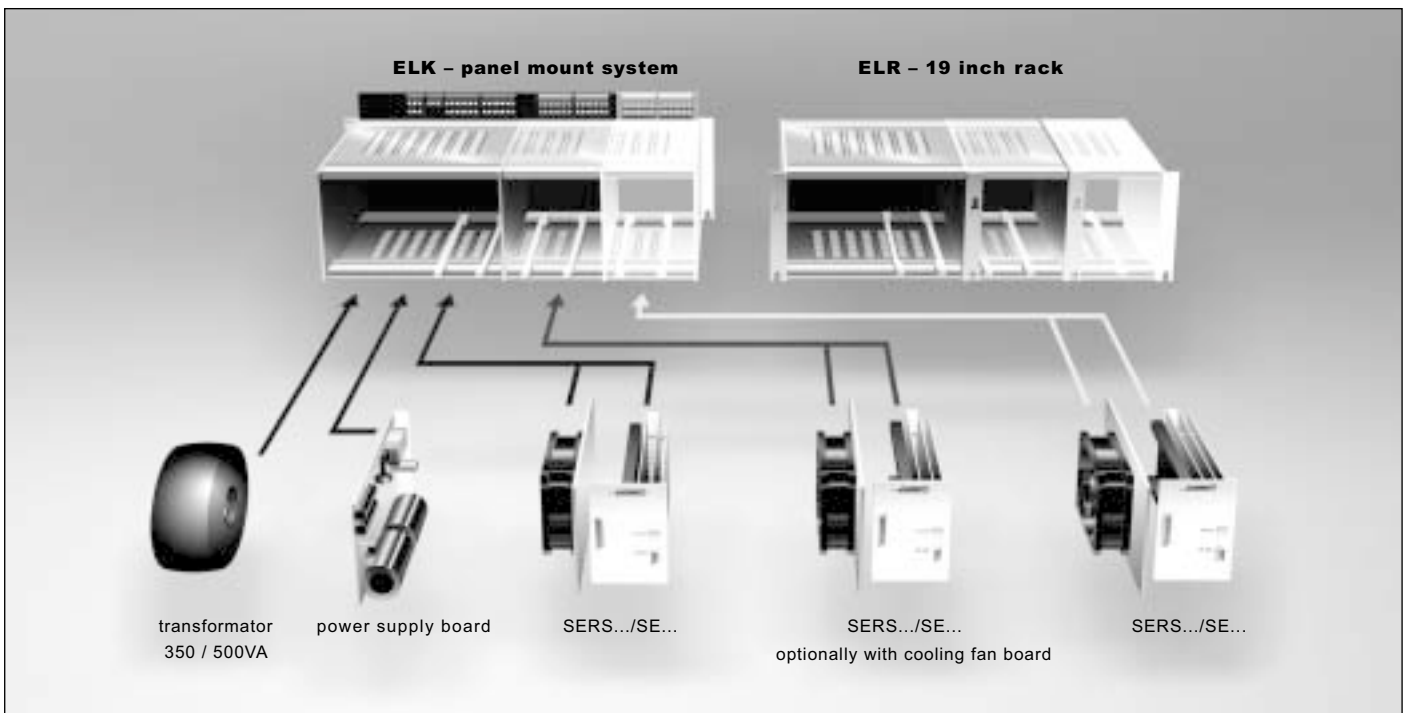

STÖGRA panel mount / 19 inch-systems series ELK / ELR 19

ELK and ELR for SE... or SERS...

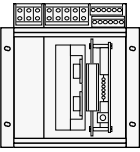
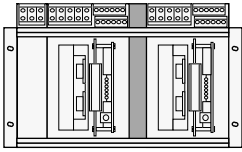
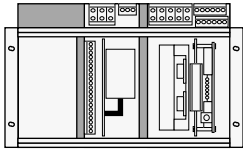
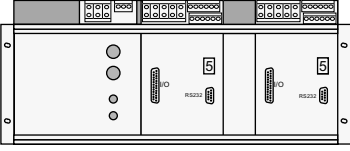
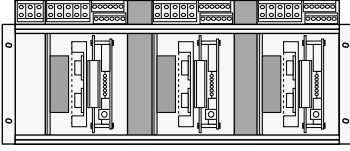
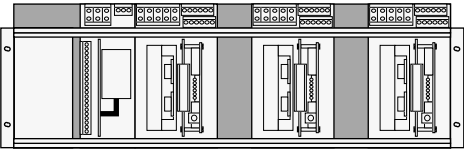
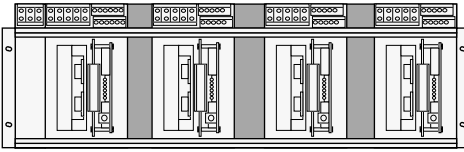
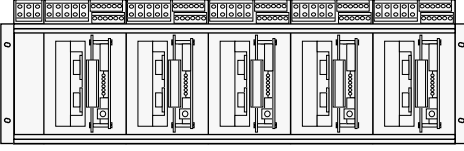
ELK...S and ELR...S for SE... or SERS...S with max. 4A phase current / 60VDC voltage supply

Other available versions for ELK- and ELR-racks:

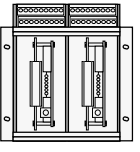
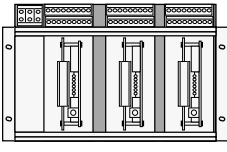
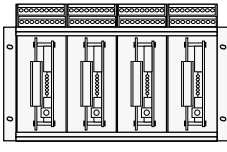
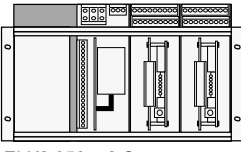
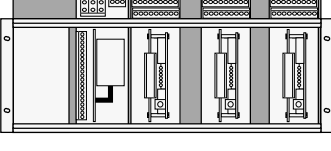
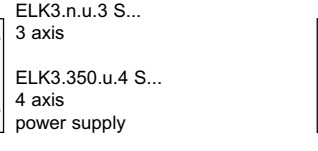
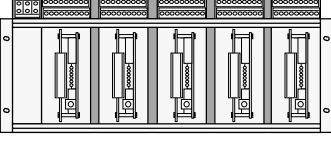
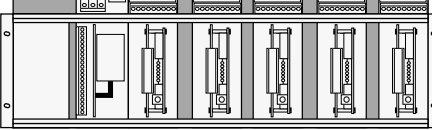
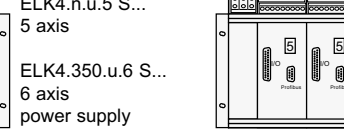
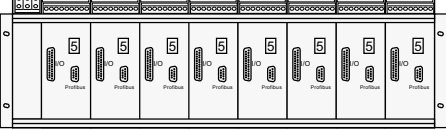
- Less plug ports than physically possible in the rack → e.g. ELR4.n.u.1 (ELR4.350.60/24.1)
→ 19 inch rack ELR4 with power supply and only 1 plug port for SE or SERS
- External connections for motor voltage supply option »E« also for ELK-/ELR-racks with power supply
→ e.g. ELK4.500.85/24/E.3 A3
for common voltage supply of multiple ELK-/ELR-racks via one power supply integrated in one of the ELK-/ELR-racks
- ELR-rack ELR1, ELR2 and ELR3

20 STÖGRA panel mount / 19 inch-systems series ELK / ELR

ELK dimensions and connections

Dimensions: 8.15, 10.3 x 6.8, 57.15, 132.5, 157, 192.

	A	B
ELK 1	158	118
ELK 2	270	230
ELK 3	376	336
ELK 4	483,5	443,5

SE...

- 5 ready signal (+)
- 6 pulse
- 7 disable
- 8 step angle
- 9 GND
- 10 24VDC
- 11 ready signal (-)
- 12 reset
- 13 boost
- 14 direction
- 15 GND
- 16 24VDC

SERS

- ready signal (+)
- Stop switch
- limit switch left
- opto GND
- GND (24VDC)
- 24VDC
- ready signal (-)
- home switch
- limit switch right
- service switch ext.
- GND (24VDC)
- 24VDC

Terminal labels: L1, N, PE, GND (24VDC), GND (VCC), PE, phase 1 (1, 2, 3, 4), phase 2 (1, 2, 3, 4).

screw terminals

ELR dimensions and connections

Dimensions: 8.15, 10.3 x 6.8, 57.15, 132.5, 185, 205.

	A	B
ELK 1	158	118
ELK 2	270	233
ELK 3	376	336
ELK 4	483,5	446,6

Terminal labels: L1, N, PE, GND (24VDC), GND (VCC), PE, +VDC, 0V GND, phase 2 -, phase 2 +, phase 1 -, phase 1 +.

interface for SERS with option R1 or R2 connection RS232 R 9-pole D-Sub-connector

- Pin 1
- Pin 4
- Pin 5
- Pin 7
- Pin 8
- Pin 9
- Pin 10
- Pin 11
- Pin 12
- Pin 13
- Pin 14
- Pin 15
- Pin 16

I/O-signals for SERS with option R1 or R2

- 24VDC
- VCC OUT
- GND OUT
- GND (24VDC)
- 24VDC
- GND IN
- GND (24VDC)
- ADC neg
- ADC pos
- 11
- O4
- O3
- O2
- O1
- 18
- 17
- 16
- 15
- 14
- 13
- 12
- 16
- 15
- 14
- 13
- 12
- 11
- 10
- 9
- 8
- 7
- 6
- 5
- 4
- 3
- 2
- 1

connection

SE...

- 5 ready signal (+)
- 6 GND (VCC)
- 7 pulse
- 8 disable
- 9 step angle
- 10 GND (24V)
- 11 ready signal (-)
- 12 GND (VCC)
- 13 reset
- 14 boost
- 15 direction
- 16 +24VDC

SERS

- ready signal (+)
- GND (VCC)
- Stop
- limit switch left
- Opto-GND
- GND (24V)
- ready signal (-)
- GND (VCC)
- home switch
- limit switch right
- service sw. ext.
- +24VDC

STÖGRA panel mount / 19 inch-systems series ELK / ELR 21

ELK ...S connections

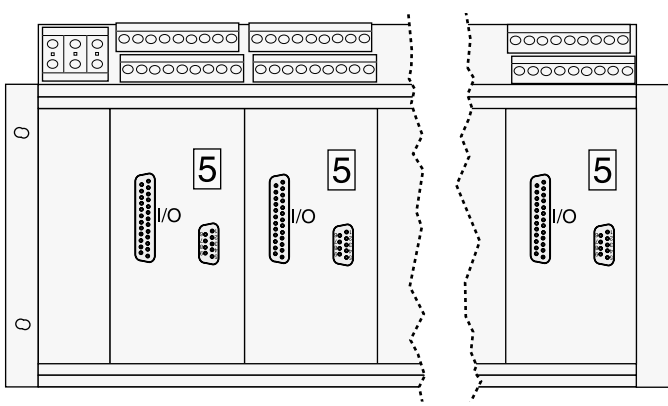

SE...	SERS...
1: PE / Shield	1: PE / Schirm
2: Motor phase 1	2: Motor Phase 1
3: Motor phase 2	3: Motor Phase 2
4: Ready signal	4: Ready signal
5: Pulse	5: STOP
6: Disable	6: Limit switch left
7: Step angle	7: Opto-GND
8: GND	8: GND (24VDC)
9: +24VDC	9: +24VDC
11: PE / Shield	11: PE / Shield
12: Motor phase 1	12: Motor phase 1
13: Motor phase 2	13: Motor phase 2
14: Ready signal	14: Ready signal
15: Reset	15: Home switch
16: Boost	16: Limit switch right
17: Direction	17: Service switch extern
18: GND	18: GND (24VDC)
19: +24VDC	19: +24VDC

ELR ...S connections

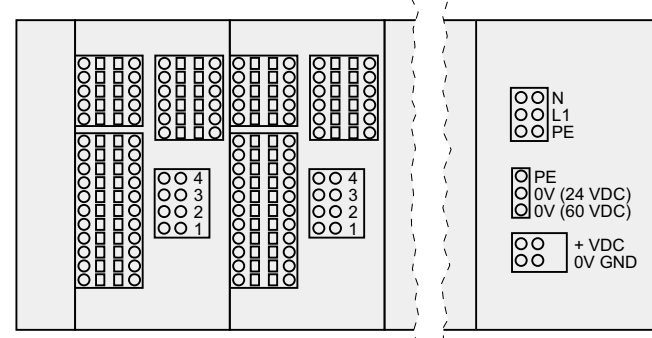

connection	SE...	SERS
5	Ready signal (+)	Ready signal (+)
6	GND (VCC)	GND (VCC)
7	Pulse	STOP
8	Disable	Limit switch left
9	Step angle	Opto-GND
10	GND (24V)	GND (24V)
11	Ready signal (-)	Ready signal (-)
12	GND (VCC)	GND (VCC)
13	Reset	Home switch
14	Boost	Limit switch right
15	Direction	Service sw. ext.
16	+24VDC	+24VDC

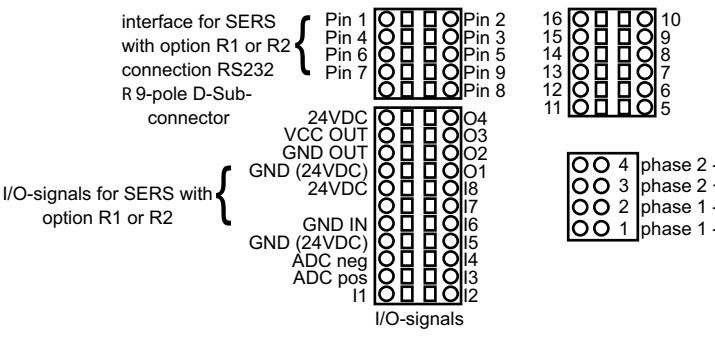

interface for SERS with option R1 or R2 connection RS232 R 9-pole D-Sub-connector

Pin 1, Pin 4, Pin 6, Pin 7

Pin 2, Pin 3, Pin 5, Pin 9, Pin 8

Pin 16, Pin 15, Pin 14, Pin 13, Pin 12, Pin 11

Pin 10, Pin 9, Pin 8, Pin 7, Pin 6, Pin 5

24VDC VCC OUT GND OUT GND (24VDC) 24VDC

GND IN GND (24VDC) ADC neg ADC pos 11

O4 O3 O2 O1 O8 O7 O6 O5

I/O-signals

phase 2 - phase 2 + phase 1 - phase 1 -

22 STÖGRA panel mount / 19 inch-systems series ELK / ELR

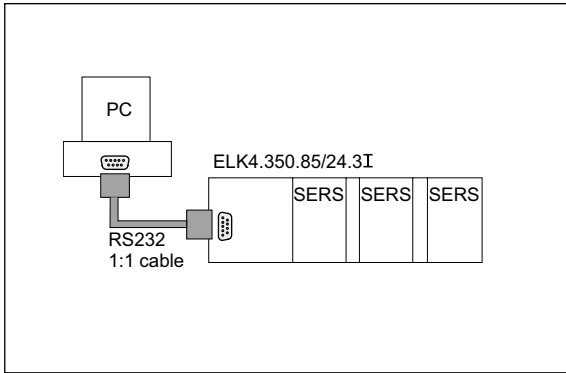

Option »I« for ELK (for SERS with RS232):

Common interface connection for all SERS in a ELK-rack
– when connecting an ELK-rack with SERS units to one common RS232-interface of a PC.

Connection PC-ELK via a 1:1 cable.

The SERS boards must be ordered with option R4.

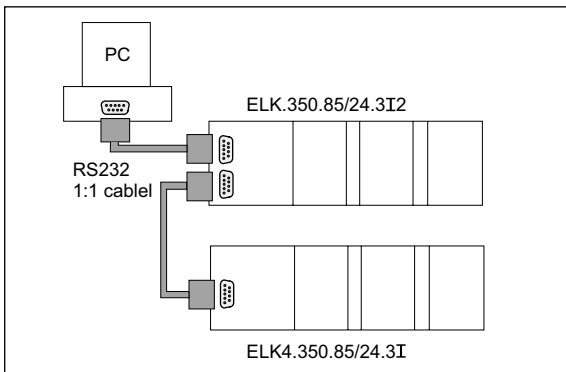

Option »I2« for ELK (for SERS with RS232):

2 common interface connections for all SERS in a ELK-rack

→ RS232 – input and output when connecting multiple ELK-racks with SERS at one common RS232-interface of a control (e.g. PC).

Connection PC-ELK-ELK is via 1:1 cabel.

SERS must be ordered with option R4.



ELK2.350.85/24.1 P with SERS 06.85 V04 R4

Option »P« for ELK or ELR for integrating a SERS-Programmer into the rack (at front side):

The SERS-Programmer must be ordered separately.

When using ELK-racks the SERS boards must be ordered with option R4 or R5, when using ELR-racks the SERS boards need option R1 or R2.

Option S: Small plug ports for SERS...S position controls or SE 01.. / SE 02.. / SE 03.. / SE 04.. (until 60VDC) power amplifier boards.

Option V: For using with SE ... power amplifier boards (for standard SERS position controls do not order option »V«) or for using with SERS position controls with option »U« (seperate 24V logic supply)

Option E: Connection for external supply of the motor supply DC voltage (for ELK-racks without power supply) respectively for the DC voltage supply of other ELK-racks without power supply

Cover of ELK / ELR racks:

Top side and bottom side: Aluminium plates with air ventilation slots.

Rearside: ELK-racks with 10 mm PVC plate

Front side: SERS-boards in standard version with front panels – SE-power amplifier boards without front panels

STÖGRA panel mount / 19 inch-systems series ELK / ELR 23

Technical specifications:

protection class	protection class IP20		
weight	type	ELK / ELR with power supply	ELK / ELR without power supply
	weight	6,2 kg – 7 kg (depending on version)	1,8 kg – 2,6 kg (depending on version)
RoHs conformdirective to 2002/95/EC			

ELK/ELR ordering key

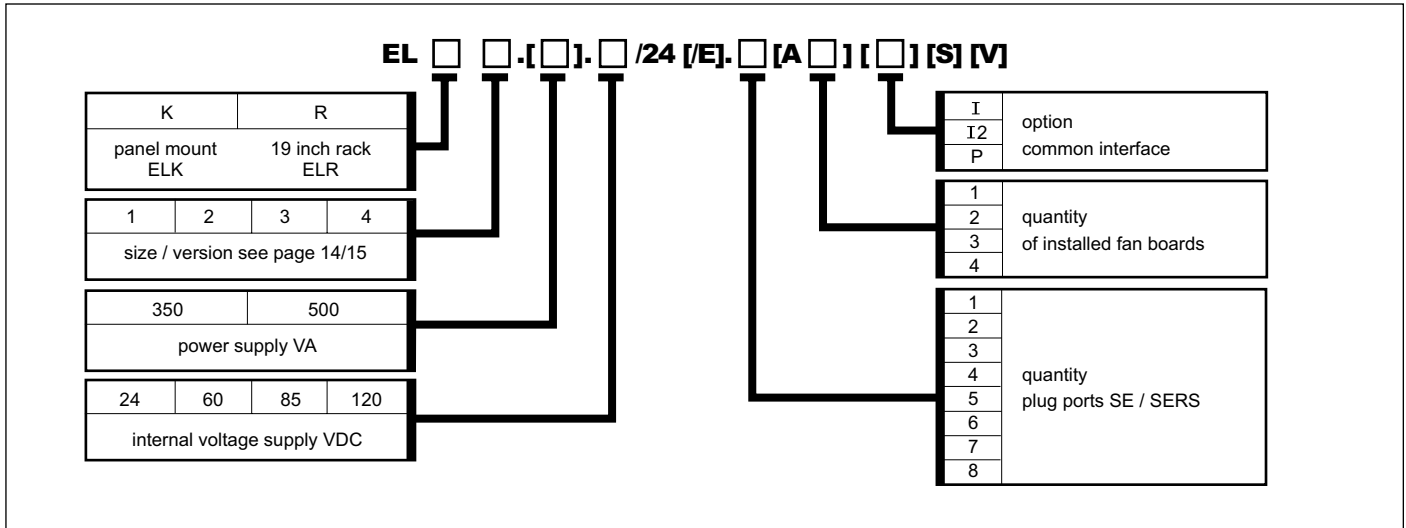

Ordering examples: ELK2.350.85/24.1 V ELK3.500.120/24.2 A2 I ELK3.60/24/E.5 I2 S ELR4.350.85/24.3 A3 P